

Detailed Energy Data Collection for Miscellaneous and Electronic Loads in a Commercial Office Building

*H.Y. Iris Cheung, Steven Lanzisera, Judy Lai and Richard Brown,
Lawrence Berkeley National Lab*

Stephen Dawson-Haggerty, Jay Taneja and David Culler, University of California- Berkeley

ABSTRACT

Miscellaneous and electronic loads (MELs) consume about 20% of the primary energy used in U.S. buildings, and this share is projected to increase for the foreseeable future. Our understanding, however, of which devices are most responsible for this energy use is still rudimentary. Developing efficiency strategies for these products depends on collecting data that describes their diversity and varied usage patterns. Few studies have collected field data on the long-term energy use of MELs, due to the difficulty and expense of traditional power meters. Recent advances in wireless technology, applied to power meters, provide a relatively inexpensive metering method and allow for large-scale, long time-series data collection.

In order to cost-effectively generate representative MELs energy data for future studies, this study addressed the following important methodological questions in a typical office building: 1) How much of the building floor area should be inventoried, 2) What fraction of the inventoried devices should be metered, 3) How long should these devices be metered, and 4) At what sampling intervals should power data be collected? We performed a full MELs inventory in an 89,500 square-foot office building and subsequently deployed a total of 455 wireless power meters on sampled devices, for periods of 6-16 months. We concluded that in the study building, performing a device inventory for 25% to 30% of the floor area and metering 10% to 20% of the inventoried devices from key device categories, for a period of two months, would have generated meaningful and accurate data to inform MELs energy use.

Introduction

Background

Buildings account for 40% of the total primary energy consumption in the U.S., with 22% consumed by the residential sector and 18% by the commercial sector. About 20% of the primary energy is consumed by miscellaneous and electronic loads (MELs), and this end use is projected to grow to one-third of the primary energy used in U.S. buildings in the next 20 years (DOE 2009). MELs energy use is spread among many devices and product categories, and usage of these devices is often closely tied to users' activities and behaviors. The services provided and the drivers of energy use also vary greatly among the end uses within MELs. As a result it is difficult to develop energy-use reduction strategies, and strategies may not be effective across successive generations of products as new features and functionalities are introduced. One of the first steps in reducing MELs energy use is to understand the scope, characteristics, and magnitude of MELs consumption, in order to come up with effective and scalable strategies. Below, we provide an overview of our current knowledge on MELs to identify the data gaps to be filled.

Related Research on MELs Energy Use

National Building Survey

The most comprehensive top-down studies of the MELs end-use in the U.S. are based on national surveys of a few thousand residential and commercial buildings, in which monthly, whole-building utility bills are collected. These monthly bills are then statistically disaggregated to estimate end-use energy consumption, using building characteristics, equipment ownership, and exogenous factors such as weather to explain variation in energy use. In these models, MELs are included in the “Other” end-use, which is simply a statistical residual that cannot be attributed to one of the traditional end-uses (heating, cooling, lighting, etc.) and is therefore subject to errors due to data collection or model specification in these traditional end-uses.

Bottom-Up Estimates

Another study approach is to use energy-consumption data from controlled, laboratory conditions, combined with shipment and stock data, to produce bottom-up estimates of MELs energy use by device type. These studies have been developed for the residential (Urban et al. 2011) and commercial (McKenney et al. 2010) sectors in the U.S. While the engineering approach provides a detailed energy estimate for each product category, data for shipment, stock, device power consumption, and usage patterns are subject to different levels of uncertainty.

Branch-Circuit Metering

This involves conducting metering at the branch-circuit level in buildings to identify large individual loads (e.g. furnaces). Due to data storage and processing limitations, typically ten to fifteen circuits or devices were monitored in the homes, and energy measurements were taken every ten to fifteen minutes. Depending on the study, monitoring lasted from one month to one year. While these studies are an important basis for our knowledge of energy use in buildings, they are best at identifying the consumption of large devices such as furnaces, water heaters, and refrigerators, and in determining the energy shares of major end uses.

Non-Intrusive Load Monitoring (NILM)

NILM collects data at the circuit breaker levels and uses algorithms to disaggregate loads by recognizing energy use signatures of specific devices and reporting their power draw and operation time. NILM has been studied since the 1980s but established methods have mainly been applied to large appliances. The challenges of using NILM on MELs lie in that the relatively small power draw of MELs tend to be confused with fluctuations in the circuit, hence more sophisticated techniques and algorithms are needed. If these technical challenges are overcome, NILM would be a less intrusive and cost effective method to collect MELs data.

Device-Level Metering

With the proliferation of MELs over the last 20 years, a reliable and more intensive style of metering—at the individual device level—is needed to properly characterize energy use of

these devices. In the US, MELs metering has been conducted in both residential (Porter et al. 2006) and commercial (Moorefield et al. 2011) buildings in California, and also for residential buildings in Minnesota (Bensch et al. 2010). The data collected through these studies significantly improved the state of knowledge of MELs energy use in U.S. buildings. The main limitation is that the expense of the metering equipment limits the number of devices per building that can be metered. Because of the wide diversity of MELs devices found in buildings, it is important to be able to meter a large number of devices per building. Also, the meters all used on-board data storage, which limits the length of the metering period and the frequency of energy measurements.

Study Objectives

To address the limitations of these earlier studies, it is important to develop MELs field metering techniques that are more cost-effective and allow more frequent meter readings over longer time periods. The goal of this study was to take advantage of recent developments in wireless sensor networks to develop a MELs field study methodology that was relatively low-cost, reliable, and allowed metering of a representative sample of MELs devices in a commercial office building. Another major goal of this study was to further refine field methods for conducting inventory and metering of MELs devices. We deployed 455 wireless power meters in a commercial office building on the Lawrence Berkeley National Lab (LBNL) campus for time-series data collection. Although a major part of the study also involved the residential metering deployment in three study homes, the results drawn for this paper are from the energy measurements of the office building alone. The time-series data collected from the office building aim to address four important methodological questions.

1. How much of the building floor area should be inventoried?
2. What fraction of the inventoried devices should be metered?
3. How long should these devices be metered?
4. At what sampling intervals should power data be collected?

Addressing these methodological questions will help inform future MELs energy measurement studies by providing some basis for setting metering parameters, but it is important to keep in mind that this single building is not representative of all of the diversity present in buildings. Results from this paper should be taken as relevant to the building metered, and use of these results to guide future studies should be done with care.

Data Collection System

The wireless power meters used in this study are a research platform called ACme (“AC meter”) developed by the University of California, Berkeley (Jiang et al. 2009b) and refined for use in this study. The final version used in this study consumed 0.4W per meter, had a significantly smaller form factor, and was capable of handling 15A currents for extended periods of time. Figures 1 and 2 show size of the ACme, and the typical configuration when the ACme is connected to a device for metering, respectively.

Figure 3 shows a schematic of the overall ACme metering system design, with particular emphasis on the networking. Overall, the system can be decomposed into three tiers: the metering tier, Ethernet networking, and datacenter tier. The metering tier is made up of a large

number of ACmes, each containing a microcontroller integrated with a radio and energy metering chip. Each device runs the TinyOS operating system and uses the open-standard 6LoWPAN network protocol to provide IPv6 (a dynamic, scalable routing protocol) network connectivity (Dawson-Haggerty 2010). To provide scalability to hundreds of ACmes, the Ethernet networking consists of a number of load-balancing routers (LBRs), or referred to as edge routers in this paper, that provide connectivity to and from the ACmes. Each LBR advertises a minimum-cost path to neighboring meters; each meter then chooses the LBR with the lowest cost path as its default router, and sends all traffic to the selected LBR. This allowed us to increase both network and backhaul capacity by deploying new meters and routers at will. Data generated by the meters are sent in User Datagram Protocol (UDP) packets, through the LBRs, to a server in our datacenter. The datacenter tier makes up the final part of the system, which runs a hosted web application for visualization. Data packets can travel through the Internet, allowing us to share this backend infrastructure between this and meter deployments in other physical locations.

ACme meters provide data readings as frequently as every second; a sampling interval of 10 seconds was selected for this study to optimize network traffic and data transmission. These meters are well suited to research applications because they are based on an open platform that can be improved and adapted for a given project (Jiang et al., 2009a and 2009b). ACme nodes automatically join the IPv6 subnet after being plugged in and begin interactions with the application layer. Due to the small size and use of commodity parts, the purchase cost of the ACme system is approximately \$75 per node and \$250 for an edge router.

Figure 1. ACme node (scale in inches)



Figure 2. ACme node, measuring notebook

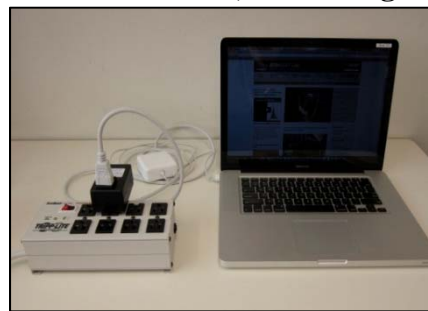
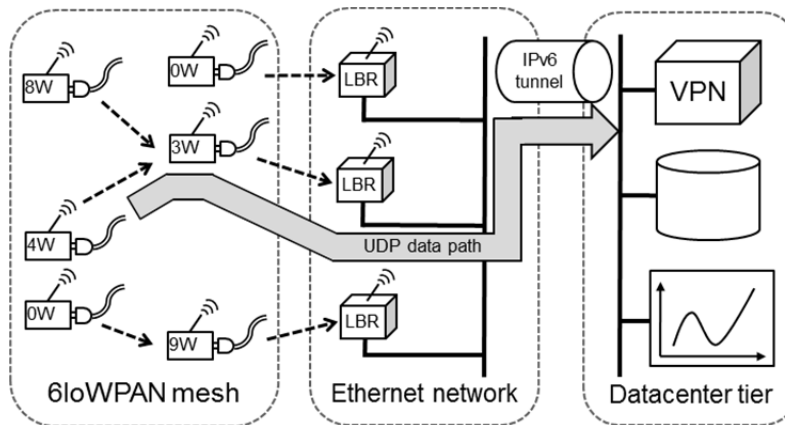

Figure 3. ACme system design



Meter Calibration and Accuracy

Because of the differences among meters caused by variations in the manufacturing process, all meters were tested, calibrated, and programmed before deployment to ensure accurate and consistent measurements in the field. The calibration procedure utilized 21 calibration points between 0 and 300W, and the calibration results for the 455 meters deployed are shown in Figure 4. The plot shows cumulative distribution functions at four load levels. At low loads, we achieve absolute errors of less than 1W for virtually all of the meters calibrated. Additionally, more than 75% of meters are within 2% of the measured load at 60W, the standard for “utility grade” metering, with improved accuracy as the load increases.

Figure 4. Error of calibrated meters at four load levels

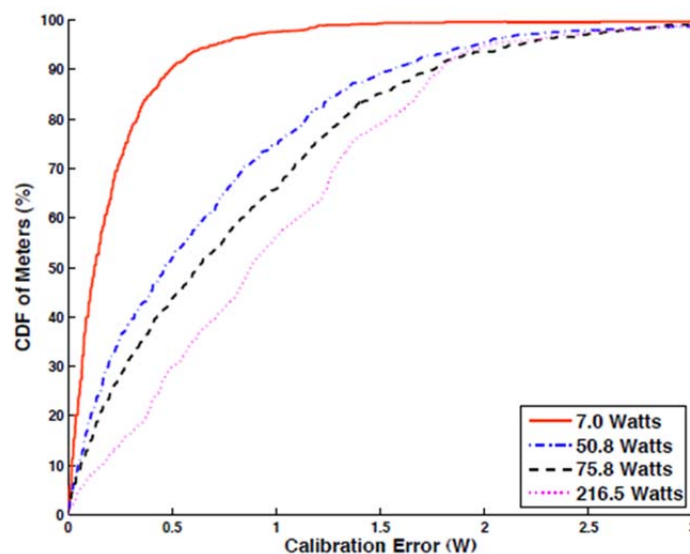

Methodology

Device Inventory

Taxonomy. Due to the diversity of MELs encountered, a standardized system of identifying and recording MELs is essential for inventory and energy data analysis. Nordman and Sanchez (2006) developed a taxonomy of MELs for a California Energy Commission study, and we augmented this taxonomy by referencing other existing taxonomies (Energy Star product categories and California Energy Commission appliances list). The taxonomy consists of three levels - End Use, Category, and Product Type. MELs are divided into three major end uses – Electronics¹, Miscellaneous², and Traditional³. Each end use is composed of different device

¹ Devices for which their primary function is information (obtaining, storing, managing, or presenting) (Nordman and Sanchez 2006)

² Includes devices that serve the major end uses in a building but are usually not included in the energy consumption of major end uses, e.g. portable fans, space heaters.

³ The Traditional end use includes HVAC, Lighting, Major Appliance, and Water Heating. Depending on the building type and its major function, these end uses may be regarded as MELs or non-MELs. For example, in a

categories, and each category contains many product types. For example, a “LCD computer display” is a product type in the “Display” category, which is part of the end use “Electronics”. During the study, we expanded and fine-tuned the taxonomy, as we encountered new device types during the inventory or to describe certain devices in a more consistent way.

Inventory methods. Before conducting the extensive MELs inventory as part of our field work, we explored different inventory methods, seeking compromise between time and effort, quality and quantity of information gathered, and minimizing disturbance to building occupants:

- Voice recognition, with instant transcription;
- Paper, with electronic transcription after inventory;
- Videotaping, with electronic transcription after inventory;
- Direct electronic entry (typing) in spreadsheet.

We tested and timed each of the listed methods and found that the direct electronic entry method is best suited for both the residential and commercial settings. The inventory was best done with a two-person team, with one person searching for MELs in the inventory space and reading out relevant data while the other person input data directly into a spreadsheet using a notebook computer. This saved time by combining data entry and transcription into one task. In addition, given the long lists of MELs included in the taxonomy, we found that auto-completion and look-up capability of the taxonomy in the spreadsheet greatly facilitated the process of identifying and recording MELs consistently.

Meter Deployment

The commercial study building is a 1960s era facility located on the LBNL campus largely used as a traditional office space. It has a total floor area of 89,500 square feet. Approximately 450 occupants in six working groups are located on four floors and a basement. In order to address the research questions of how much of the building floor area should be inventoried and what fraction of the inventoried devices should be metered, we opted to perform a full MELs inventory of the building, which resulted in approximately 5,000 MELs.

MELs sampling. With such a large number of MELs in our study building, metering all devices would be time- and cost-prohibitive, and not all data generated would provide useful insights. With a goal of installing meters on 10% of the inventoried MELs, we developed a multi-stage, stratified random sampling approach to select devices for metering. Devices were divided into stages by physical location or organization owning the devices. For each stage, a subset of devices was then selected from a stratified sample by Device Category to meet our data collection objectives. A stratified sample is critical because a simple random sample would result in metering a large number of uninteresting devices (e.g. computer speakers, external disk drives) while also not metering as many devices with significant energy use such as computers or LCD displays.

commercial food processing building, refrigeration would be a process load and not a MEL, while in a residential home, refrigerators are considered MELs, under this Traditional end use.

MELs metering. In the second phase of the study, we deployed a total of 455 meters on the sampled devices. The deployment took approximately 120 person-hours, which involved about equal amount of time obtaining written consent from individual occupants and physically installing the meters. We also installed 2 edge routers per floor on the four floors of the building we conducted metering. No meters were installed in the basement of the building because of small floor area, low device density, and relocation and movement of occupants during the project execution period. Time-series energy data were collected in the commercial building from 6 to 16 months, as we deployed the meters in a few stages but uninstalled them all at once.

Results

Overview

The diversity of MELs metered and the sampling frequency allowed us to measure detailed energy use and usage patterns over the metering period of 6 to 16 months. Figure 5 presents the count as well as annual energy consumption of devices in the top seven energy-consuming categories and all other metered devices for the office building. Energy estimates for the entire population are projected from the metered sample of devices using sample probability weights, and energy is projected from the metering period to the entire year. Computers use the most energy overall and significantly more energy per unit than most other categories, whereas the “Other” category of devices shows the opposite behavior. Because the building is primarily office space, displays, imaging and network equipment⁴, and miscellaneous (i.e. task) lighting⁵ are the next largest MEL energy users. Space heating and fans make up most of miscellaneous HVAC, and the appliances are primarily refrigerators found in break rooms and a few offices. The energy breakdown shows that information technology equipment consumes over 75% of the annual MELs energy but is less than half of the total devices, suggesting that IT devices should be disproportionately metered more when studying MELs energy use in offices. The remainder of the Results section is devoted to answering the methodological questions raised in the Study Objectives section.

Figure 5. Inventory and Estimated Annual Energy Consumption, for the Top 7 Energy-Consuming Device Categories

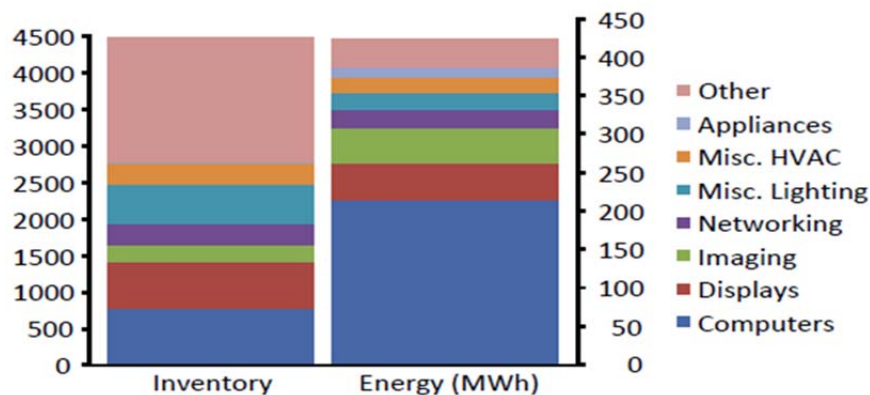

⁴ Examples of network equipment include switch, router, and wireless access point.

⁵ The term “miscellaneous lighting” refers to lighting load that is not part of the main building design; example includes plugged-in lighting and building emergency lights.

How Much of the Building Area Should Be Inventoried?

Collecting a complete inventory in a building is too time consuming to be warranted in most cases, and we believe it may be possible to inventory only a subset of the building and project this sample to the entire building with reasonable accuracy. Several factors must be considered before selecting a sampling method for inventorying. It is critical to review sources of variability in the inventory between different rooms so that the audit is as representative as possible. For example, if you only sample offices, you will not capture appliances located in break rooms, network equipment, and servers located in closets, etc. It is therefore important to stratify your sample based on factors that are likely to influence room inventory. In our case study office building, there are several such room types worth separating, and we used the following space type categories.

- Offices and cubicles
- Server closets
- Network closets
- Conference rooms
- Facilities spaces
- Kitchens and break rooms.
- Rooms used for an IT function (e.g. offices of department IT workers).
- Rooms with large imaging equipment

In order to evaluate if this projection could have been done accurately in our test building, we used our complete inventory data and created random samples from that inventory of varying size. For simplicity we only considered office and cubicle spaces, but a similar technique could be used for other space types. We selected a random number of rooms and projected the inventory to the building. Figure 6 shows the 90th percentile error in inventory normalized by the true inventory for the buildings offices and cubicles, versus the fraction of offices and cubicles inventoried. Device types with less variability office to office can be accurately inventoried with a smaller sample size while devices with greater variability need a larger sample. This is apparent in that the error is lowest for computers and monitors but much higher for imaging equipment. Most offices do not have a printer, and a large sample is required to accurately characterize the number of devices in the building. It appears that inventorying roughly one-quarter of the building makes errors less than 10% likely on computers and displays (over half of the total MELs energy use in the building). Supplementing this inventory with a complete inventory of large imaging equipment (e.g. copiers), server or network closets, and break rooms would have likely provided an accurate inventory in roughly one-quarter the time it took to inventory the entire building.

What Fraction of the Inventoried Devices Should Be Metered?

In large buildings, it is impractical to meter every device of interest. We selected a random sample of devices to meter, but we did not have a concrete basis upon which to select the number of devices to meter. We divided up our available meters roughly according to how much energy we thought devices consumed (i.e. we metered a greater fraction of devices that consumed more energy than those that consumed less) and according to how much variability in

usage we expected to find between devices (i.e. devices with greater usage pattern variability device to device were metered with higher probability).

With our measured results, we can determine how many devices of different types we should have metered to get a specific “tightness” in our confidence intervals on energy use. To do this for a category of devices (e.g. computers), we calculate the 90% confidence interval for the mean energy use, expressed in Unit Energy Consumption (UEC), for devices in that category using our metered data, shown in Column D of Table 1. We then determine the sample size required by recalculating the confidence interval for different sample sizes (Column E of Table 1). If a confidence interval of 20% of the mean annual unit energy consumption is acceptable, computers required a sample size of about 10% (i.e. 101 of 921) while imaging equipment required a sample size of about 20% (i.e. 48 of 262). As shown in Table 1, without knowing these results in advance, we over-sampled displays and under-sampled imaging equipment, miscellaneous lighting, and small network equipment.

Figure 6. Normalized 90th Percentile Error vs. Fraction of Building Inventoried, shown for 6 Device Categories

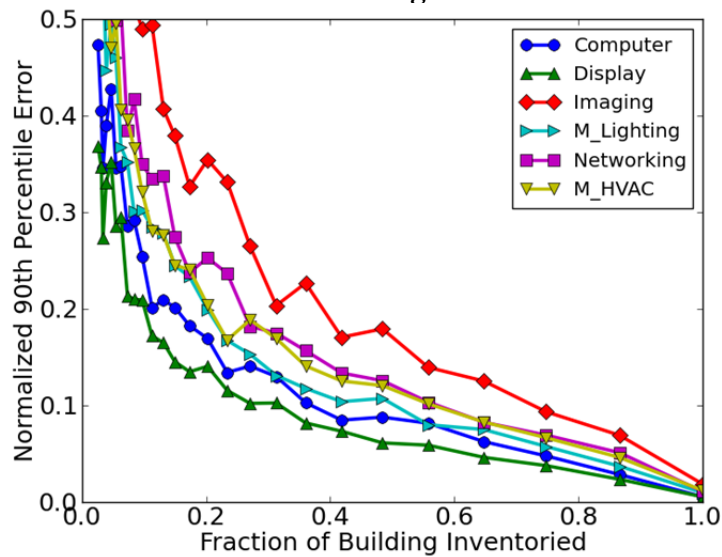

Table 1. Sample Size versus Confidence Interval for Various Device Categories

Category	A	B	C	D	E			
					Normalized Confidence Interval, n required			
					0.25	0.2	0.15	0.1
Computers	921	104	287 ± 56 kWh	65	101	179	401	
Displays	686	95	47 ± 4 kWh	10	16	28	63	
Imaging Equipment	262	31	36 ± 9 kWh	31	48	86	192	
Misc. Lighting	644	29	32 ± 10 kWh	48	75	133	299	
Small Network Equipment	310	14	32 ± 14 kWh	40	62	110	247	

How Long Should Sampled Devices Be Metered?

Many end-use metering studies are limited in duration because of hardware limitations or other logistical considerations, thus the duration of many studies are determined by guessing how long of a period is long enough to accurately predict annual energy use patterns. In this study all devices were metered for over 6 months and many devices were metered for a year. Therefore it is possible to consider various simulated metering periods for the same devices and compare estimates across different metering periods. Figure 7 shows how our estimate of total energy use by category improved with longer metering periods as compared to our best estimates of those categories energy use (best estimates were made using all metered data available for the entire metering period). The high level conclusion from this plot is that for many common device categories in the study building, metering over periods longer than a few months provides little improvement in estimating annual energy use. Some categories have a high degree of variability (e.g. miscellaneous lighting which is potentially linked with seasons), and longer metering periods are needed. We estimate that metering for two months provides about the best tradeoff between accuracy and limiting the duration of metering for devices without a significant seasonal or other source of variability, resulting in a normalized standard error of 10% as shown in Figure 7.

Figure 7. Normalized standard error for different metering periods, shown for computers, displays, plugged lighting, and imaging equipment

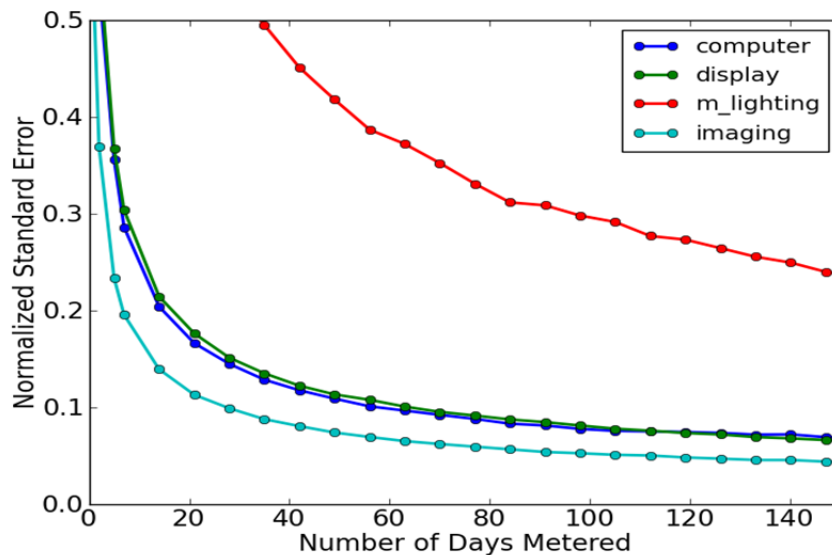

At What Sampling Intervals Should Power Data Be Collected? Depending on the purpose of the study, this enabled us to determine an optimal sampling rate for future metering activities.

Figure Figure 8 shows the time-series power data collected for a LCD computer display, as an example to show the optimal sampling period that properly captures MELs power draw. For this device, 1-minute data capture the dynamics appropriately, because most activity occurs on time scales greater than 1-min. 5-min data starts to lose some resolution on the faster dynamics between hours 7 and 8 while 15-min data are simply not fast enough to resolve the

power trace correctly. The very short power spike between 10 and 11 hours is not correctly captured by 1-min data, but these events are rare. Fine enough time resolution is important for understanding the time devices spend in various power modes. For devices with few power modes and more constant power draw, such as network equipment, high resolution is not necessary to capture the device's power dynamics, whereas for devices with rapid changes in power states, more frequency sampling intervals are required to understand power draw behaviors. Although 1-min is an appropriate resolution for a majority of MELs, we collected power data at 10-second intervals to ensure we sampled fast enough to capture any spikes in power that may occur at frequencies less than 1 minute (e.g. the power spikes that occur when an imaging device is being powered up). Depending on the purpose of the study, this enabled us to determine an optimal sampling rate for future metering activities.

Figure 8. Time series data of a LCD computer display shown for three different data sampling rates.

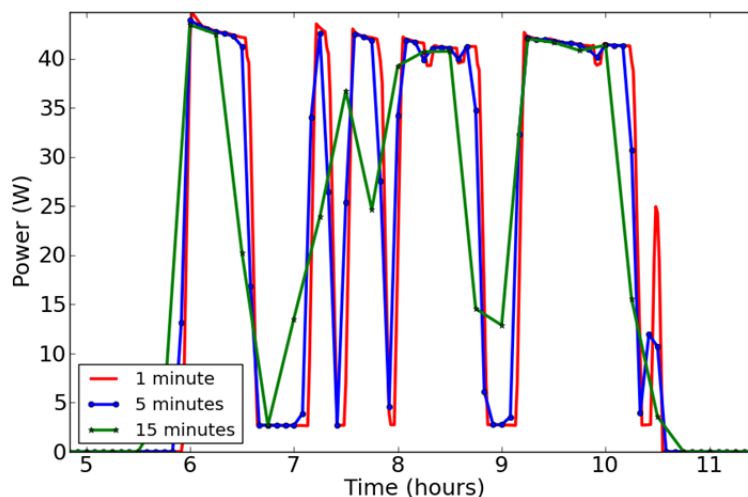

Conclusions

Over the past decade, substantial efficiency improvements have been realized in most major end uses, making the “Other” end use a bigger share of total electricity consumption. At the same time, the increased market penetration of electronic products combined with the pace of technology change and their shorter lifecycle create challenges in understanding and reducing MELs energy consumption. Improved and focused data collection on MELs energy use is critical in identifying mitigation strategies, but in the past, this has been difficult to implement due to the limitations of traditional power meters and the high density of MELs in commercial and residential spaces. In this study, we deployed 455 wireless power meters in an office building, with power data collected at 10-second intervals for 6 to 16 months. The use of wireless network technology provided a lower cost alternative and required less maintenance, which subsequently allowed for long metering period and higher meter deployment in the field.

This large data set allowed us to answer some important methodological questions. From our data analysis for the commercial office building, we concluded that performing a device inventory for 25% to 30% of the floor area and metering 10% to 20% from the key device categories (that were inventoried) for a period of 2 months, would have generated representative

data for our test building. These findings, although not representative of office buildings in general, provide the first quantitative basis published upon which to guide future MELs metering studies.

References

- Bensch, Ingo, Scott Pigg, Karen Koski, and Rana Belshe, 2010. *Electricity Savings Opportunities for Home Electronics and Other Plug-In Devices in Minnesota Homes: A technical and behavioral field assessment*. Madison, WI: Energy Center of Wisconsin. ECW Report Number 257-1. May. <http://www.ecw.org/ecwresults/257-1.pdf>.
- Brown, Richard, William Rittelmann, Danny Parker, and Gregory Homan. 2006. *Appliances, Lighting, Electronics, and Miscellaneous Equipment Electricity Use in New Homes*. Proceedings of the 2006 ACEEE Summer Study on Energy Efficiency in Buildings in Asilomar, CA. Washington, DC: American Council for an Energy Efficient Economy (also LBNL-62440). August.
- Dawson-Haggerty S. *Design, Implementation, and Evaluation of an Embedded IPv6 Stack*, Masters thesis, Computer Science – Electrical Engineering and Computer Sciences, University of California, Berkeley, 2010. Can be downloaded at: <http://www.eecs.berkeley.edu/~stevedh/pubs/mthesis.pdf>.
- Jiang X., Ly M.V., Taneja J., Dutta P. and Culler D. *Experiences with a High-Fidelity Wireless Building Energy Auditing Network*. Proc. of the Seventh ACM Conference on Embedded Networked Sensor Systems (SenSys'09). Ed.: Association for Computing Machinery (ACM), 2009a. Can be downloaded at: <http://buzzing.cs.berkeley.edu/~xjiang/papers/jiang09sensys.pdf>.
- Jiang X., Dawson-Haggerty S., Dutta P. and Culler D. *Design and Implementation of a High-Fidelity AC Metering Network*. Proc. of the The 8th ACM/IEEE International Conference on Information Processing in Sensor Networks (IPSN'09) Track on Sensor Platforms, Tools, and Design Methods (SPOTS '09). Ed.: Association of Computing Machinery, 2009b. Can be downloaded at: <http://buzzing.cs.berkeley.edu/~xjiang/papers/jiang09acme.pdf>.
- McKenney K., Guernsey M., Ponoum R. and Rosenfeld J. *Commercial Miscellaneous Electric Loads: Energy Consumption Characterization and Savings Potential in 2008 by Building Type*. TIAX LLC, 2010. Download at: <http://zeroenergycbc.org/pdf/2010-05-26%20TIAX%20CMELs%20Final%20Report.pdf>.
- Moorefield L., Frazer B. and Bendt P. *Office Plug Load Field Monitoring Report*. Ecos Consulting, 2008, Rev. 2011. Download at: http://www.efficientproducts.org/reports/plugload/Revised_Office%20Plug%20Load%20Report_PIER_500-06-007_RevApril2011.pdf

- Nordman B. and Sanchez M. *Electronics Come of Age: A Taxonomy for Miscellaneous and Low Power Products*. Proc. of the 2006 ACEEE Summer Study on Energy Efficiency in Buildings. Ed.: American Council for an Energy Efficient Economy, Washington, DC: 2006.
- Porter S.F., Moorefield L. and May-Ostendorp P. *Final Field Research Report: California Plug-Load Metering Study*. Ecos Consulting, 2006. Download at:
http://www.efficientproducts.org/documents/Plug_Loads_CA_Field_Research_Report_Ecos_2006.pdf.
- Urban, B., Tiefenbeck, V., and Roth K. *Energy Consumption of Consumer Electronics in U.S. Homes in 2010*. Fraunhofer Center for Sustainable Energy Systems. Final Report to the Consumer Electronics Association (CEA), December 2011.
- US DOE. *2009 Buildings Energy Databook*. U.S. Department of Energy, Office of Energy Efficiency and Renewable Energy, 2009. Can be downloaded at:
<http://buildingsdatabook.eere.energy.gov/>.
- US DOE. 2011. *Homes have more energy-efficient appliances, but the efficiency gains are partly offset by more consumer electronics* [Press Release]. Energy Information Administration, U.S. Department of Energy. March 28.
<http://www.eia.doe.gov/pressroom/releases/press355.cfm> (accessed April 5, 2011).