

TunnelLiFi: Bringing LiFi to Commodity Internet of Things Devices

Muhammad Sarmad Mir*
Universidad Carlos III de Madrid
sarmadmir2003@gmail.com

Wenqing Yan*
Uppsala University, Sweden
wenqing.yan@it.uu.se

Prabal Dutta
University of California, Berkeley
prabal@berkeley.edu

Domenico Giustiniano
IMDEA Networks, Spain
domenico.giustiniano@imdea.org

Ambuj Varshney
National University of Singapore
ambujv@nus.edu.sg

ABSTRACT

LiFi, light-fidelity, is a wireless technology that uses visible light for data transmission. It has several advantages, such as using a different part of electromagnetic spectrum than radio communication and providing enhanced privacy because light transmission is blocked by walls. Internet of Things applications with low-to-moderate data rates represent a promising arena for LiFi adoption. However, it is difficult to bring LiFi to IoT devices for several reasons, including some of LiFi's strengths. We present TunnelLiFi, a new receiver architecture that acts like a bridge between the light and radio spectrums. A key aspect of TunnelLiFi's design is the use of the unique self-oscillating mixing property of the tunnel diode oscillator, which enables the mixing of a photodiode signal with a locally generated radio frequency carrier signal while drawing under $100 \mu\text{W}$ of power consumption. In our experiments, TunnelLiFi demonstrates the ability to replicate the information contained in light signals onto radio signals at tens of microwatts, even in low-light conditions (300 lux) and at low bitrates (2.93 Kbps). We also show the potential of TunnelLiFi to support high bitrates. TunnelLiFi opens up new possibilities for LiFi technology by enabling communication in areas where light propagation is challenging. It also allows commodity IoT devices to receive LiFi transmissions using their existing transceivers, thus expanding the reach of LiFi.

CCS CONCEPTS

• **Hardware** → **Sensor devices and platforms; Wireless devices; Networking hardware.**

ACM Reference Format:

Muhammad Sarmad Mir, Wenqing Yan, Prabal Dutta, Domenico Giustiniano, and Ambuj Varshney. 2023. TunnelLiFi: Bringing LiFi to Commodity Internet of Things Devices. In *The 24th International Workshop on Mobile Computing Systems and Applications (HotMobile '23)*, February 22–23, 2023, Newport Beach, CA, USA. ACM, New York, NY, USA, 7 pages. <https://doi.org/10.1145/3572864.3580327>

*Co-primary authors equally contributed to the work. Some parts of the work was conducted when Muhammad Sarmad Mir was visiting National University of Singapore.



This work is licensed under a Creative Commons Attribution-NonCommercial-ShareAlike International 4.0 License.

HotMobile '23, February 22–23, 2023, Newport Beach, CA, USA

© 2023 Copyright held by the owner/author(s).

ACM ISBN 979-8-4007-0017-0/23/02.

<https://doi.org/10.1145/3572864.3580327>

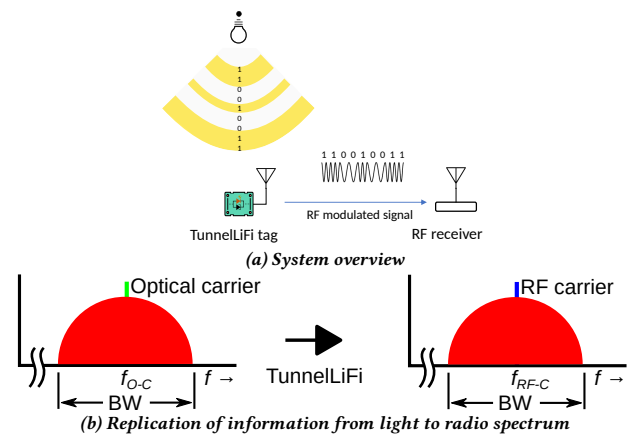

Figure 1: TunnelLiFi replicates the information in LiFi signals onto radio waves in an energy-efficient manner. These signals can be received by radio transceivers. TunnelLiFi replication happens at a peak power draw of less than $100 \mu\text{W}$.

1 INTRODUCTION

Light-fidelity (LiFi) enables wireless transmissions by rapidly modulating visible light and it offers advantages over radio frequency (RF) based technologies, including the ability to operate in less congested spectrum and being less prone to interference. LiFi can also simultaneously provide energy, illumination, and information [19], making it a good candidate for Internet of Things (IoT) connectivity. However, LiFi has yet to gain widespread adoption.

Several factors contribute to the slow adoption of LiFi technology, and in particular attempting to enter a crowded market with competing technologies. The most recent IEEE 802.11 TGbb standard has raised this issue, and its standardization effort has focused on enabling existing chipsets such as WiFi to work in the optical spectrum. However, this approach requires infrastructure retrofitting and devices to support LiFi communication, which is impractical.

LiFi technology requires changes to both the transmission and reception infrastructure. Although commercial LED lighting fixtures can be retrofitted to support LiFi communication, they are typically used for illumination and lack the necessary modulation circuitry. However, the main obstacle is the lack of LiFi-capable receivers in IoT devices. Even if manufacturers were willing to modify their devices to support LiFi, the task would be complex and difficult. As a result, there is a chicken-and-egg problem with the deployment of LiFi: without LiFi-capable devices, there is little incentive to invest in the infrastructure, and without the infrastructure, there is little incentive for manufacturers to add LiFi to their devices.

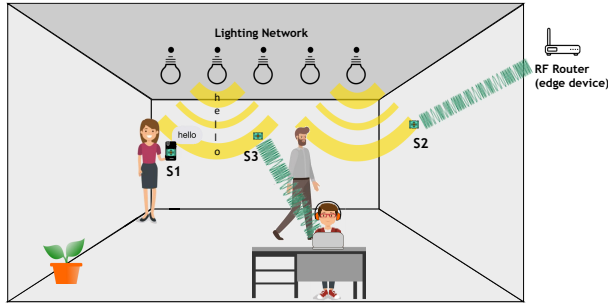

Figure 2: Examples of scenarios enabled through TunnelliFi.

LiFi’s inability to transmit through walls, which can be seen as an advantage for privacy, also limits its communication area. In many IoT applications, LiFi’s confined nature may not be desirable.

To address these challenges, we present TunnelliFi, a new LiFi receiver architecture. TunnelliFi replicates LiFi signals onto radio waves, which can then be received using existing transceivers, as shown in Figure 1b and Figure 1a. This increases the coverage area for the information in the LiFi signals and significantly expands the number of devices that can receive the information in LiFi signals.

Challenges. LiFi communication suffers from several challenges that limits its growth. First, Light cannot propagate through walls, and is naturally confined to physical spaces. From a privacy perspective, this is an advantage, since it prevents transmission of critical information outside of the space where the light is present. Nonetheless, this can also limit the applications of the technology, as it may be necessary to relay information carried via LiFi signals through walls or other closed confines without light, such as to send information to sensors placed inside the air ducts.

Another challenge lies in integrating of LiFi into IoT devices. Currently, LiFi receivers employ a pipelined architecture consisting of photodiodes, transimpedance amplifiers (TIAs), and analog to digital converters (ADC) which are power-hungry [14]. Integrating these receivers into IoT devices can negatively impact their battery lifetime. In addition, these receivers are integrated with the host microcontroller using embedded buses, such as the serial peripheral interface (SPI). As a result, modifications to existing hardware are necessary, which can be costly, time-consuming, and infeasible. Moreover, millions of IoT devices have already been deployed. The inertia of an already mature market makes it difficult to redesign and integrate LiFi receivers into these IoT devices.

TunnelliFi. We propose to rethink the LiFi receiver architecture, so that it efficiently replicates LiFi signals onto radio waves, which can then be received by radio transceivers in standard IoT devices.

A conventional approach to a TunnelliFi receiver might be implemented as follows. A photodiode tracks changes in light intensity, whose signal is then amplified by a TIA. Next, an ADC translates the amplified signal to the digital domain, followed by a demodulation process to recover the LiFi baseband information. Finally, a radio transceiver transmits this information over the radio waves. This design, however, requires several energy-intensive components, such as TIAs, ADCs, and transceivers, making it power-hungry (a few milliwatts). Furthermore, each LiFi modulation scheme would require a different demodulator and radio transceiver. Another challenge would be that each step in the pipeline may add a delay.

Design. Using tunnel diode oscillators (TDOs), we propose to simplify the architecture previously mentioned. Tunnel diodes are semiconductor devices that exhibit negative resistance characteristics, particularly at low power (tens of μW) [2, 12]. In addition, tunnel diodes operate well at radio frequencies, making them useful for designing low-power RF circuits such as oscillators and amplifiers. For example, TunnelScatter [16] demonstrates the design of a TDO that generates an RF carrier signal in the 868 MHz frequency band with under $57 \mu\text{W}$ of peak power draw. Furthermore, Judo [17] shows that TDOs can function as self-oscillating mixers (SoMs): a single circuit generates a high-frequency carrier signal that can be mixed with a low signal strength baseband signal at under $100 \mu\text{W}$. TunnelliFi builds on this promising property of the TDO.

We design a TDO to operate in the 900 MHz band. Using the SoM property of the TDO, we couple a photodiode with the TDO, as shown in Figure 3. The TDO can mix very weak signals, so we do not need to use an amplification stage like in traditional light receivers. Thus, TunnelliFi achieves very low power draw. When a modulated LiFi signal is incident on the photodiode, the optical signal from the photodiode is mixed with a locally generated RF carrier signal and radiated out of the antenna. In IoT devices, this signal is then received by a radio transceiver.

Building on this design concept, we experiment with a LiFi transmitter modulated with a frequency shift keying (FSK) and an on-off keying (OOK) modulation scheme. The following are the key highlights of the results presented in this work:

- TunnelliFi can replicate LiFi signals onto radio waves with a high throughput of up to 4.8 Mbps with OOK modulation scheme.
- TunnelliFi replicates FSK-modulated LiFi signals onto radio waves that can be received using commodity receiver CC1310. These experiments are conducted at a bitrate of 2.93 Kbps.
- TunnelliFi tag power draw is under $100 \mu\text{W}$, and it can operate at illuminance levels below 300 lux.

Application scenarios. TunnelliFi enables several scenarios, some of which are depicted in Figure 2, indicated as S1, S2 and S3. Lighting infrastructure is retrofitted with LiFi transmitter modules. In scenario S1, TunnelliFi is realized as a sensor placed on the back of an IoT device. This allows the device to receive information contained in the LiFi signals through its onboard transceiver. In scenario S2, TunnelliFi allows information contained in LiFi signals to be broadcasted via radio waves through the walls, thus overcoming an inherent limitation of LiFi signals: inability to propagate through walls. Finally, in scenario S3, TunnelliFi allows IoT devices deployed in an area covered with LiFi infrastructure to receive LiFi transmissions, even in the absence of a LiFi receiver.

2 BACKGROUND AND RELATED WORK

This section discusses the background and related work, and helps to put our system into a large context.

2.1 LiFi Receivers

A LiFi receiver typically consists of a light detector, a processing block, and interfaces. For light detection, various options are available, including photo diodes, solar cells [7, 10], LEDs, and image sensors [15]. Depending on its capabilities, and power draw, a LiFi receiver may be considered passive or active.

In active LiFi receivers, power draw is not a major constraint. Photodiodes are most commonly used, as they are highly sensitive and can support a wide bandwidth. However, signals from photodiodes are typically weak. Therefore, they require processing with multiple amplification stages of TIAs and voltage amplifiers (VAs) to make the light signal readable to the ADC, as illustrated in Figure 3a. All of these steps are power-hungry resulting in the LiFi receiver drawing milliwatts. LiFi receivers may use LEDs instead of photodiodes [5], but they suffer from low sensitivity. Furthermore, they require all the above-mentioned stages. Finally, image sensors can also be used for sensing light levels [4]. However, these sensors are also power-hungry and require intensive processing of the received signal.

Passive LiFi receivers use solar cells as light detectors and do not require a TIA or VA. Thus, energy is only required for signal conversion to the digital domain. In recent systems, this step has been performed using a comparator that acts as a 1-bit ADC [9], as shown in Figure 3b. Consequently, passive receivers require only a few microwatts to operate. Passive receivers, however, sacrifice certain capabilities to achieve this performance: their size may be large owing to solar cell limitations. Furthermore, due to their high internal capacitance, solar cells have limited bandwidth, resulting in low bitrates.

Conventional LiFi receivers must interface with the microcontroller on IoT devices through embedded buses like SPI and UART. This adds complexity and may require hardware changes, which can be costly and may not be feasible for already devices. TunnelLiFi presents a novel receiver architecture that addresses these limitations. Its power draw is similar to a passive receiver, but offers capabilities closer to an active receiver. Moreover, TunnelLiFi can interface with IoT devices through a wireless medium, eliminating the need for hardware changes to existing devices. TunnelLiFi achieves these capabilities through properties of TDOs, and a novel receiver architecture, as shown in Figure 3c.

2.2 Coverage and Non Line-of-Sight Communication

Light-based communication, or LiFi, faces several challenges in terms of coverage and transmission range. Devices that are not within line-of-sight of the LiFi transmitter may not be able to effectively communicate. Even within a room, the range of LiFi can be limited due to path loss. One potential solution to this constraint is to use high-power LED bulbs, but this may not be practical due to illumination constraints. Communication through walls may also be necessary for some applications, which presents an additional challenge for LiFi technology. TunnelLiFi overcomes these challenges by replicating the information in LiFi signals onto radio waves, which have much better propagation characteristics.

2.3 Wireless Light-sensing Systems

Prior studies have investigated the design of energy-efficient, wireless light-sensing systems. However, these systems are only capable of measuring light intensity and transmitting low-bandwidth LiFi data. For example, in [18], an radio-frequency identification (RFID) tag is modified with a phototransistor to vary antenna impedance based on light exposure. The system is capable of coarse-grained reading, but its applications are limited and it requires expensive,

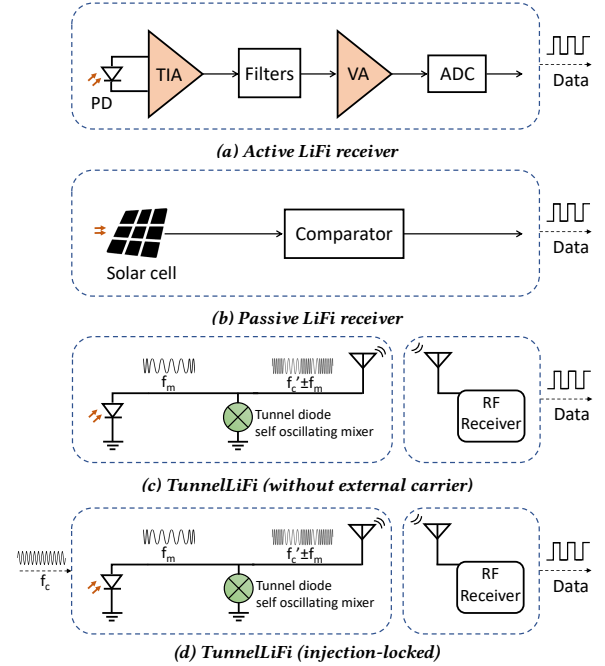

Figure 3: Comparison of LiFi receiver architectures. (a) An active LiFi receiver uses a photodiode to receive LiFi signal, amplifies the signal using TIA and VA, converts the resulting signal in the digital domain using an ADC, and interfaces with host using embedded busses. (b) A passive LiFi receiver uses a solar cell to receive LiFi signal, converts it to digital domain using a comparator, and interfaces with host using embedded busses. (c) TunnelLiFi uses a photodiode to receive LiFi signal, mixes it with carrier signal from TDO (without amplification), and transmits the mixed signal over a wireless medium, which is then received by the host using RF receiver. (d) Similar to (c), but TunnelLiFi utilizes an external carrier to stabilize the TDO, thus ensuring good link quality.

bulky, and power-consuming RFID readers. Efforts have been made to design battery-free light-sensing systems such as EDISON [7], which uses solar cells to receive low-bandwidth LiFi information and harvest energy to power the tag. However, this system suffers from the low bandwidth of solar cells and the presence of a processing block (a microcontroller) that introduces latency and leads to intermittent behavior of the tag.

Our work is closely related to PassiveLiFi [10], which uses a solar cell to receive LiFi information and transmit it via the RF-backscatter mechanism. Due to the limitations of solar cells, it can only achieve very low bitrates. In contrast, our system, TunnelLiFi, significantly improves upon PassiveLiFi. Instead of using solar cells, it uses photodiodes. Furthermore, by building on recent work that demonstrates the capabilities of tunnel diode systems [17] to overcome the limitations of backscatter systems, TunnelLiFi overcomes the communication constraints of PassiveLiFi.

3 DESIGN

We describe the design of our system. The system consists of a LiFi transmitter, a TunnelLiFi device, and an RF receiver.

3.1 LiFi Transmitter

A LiFi transmitter consists of an LED, a baseband generator, and an LED driver circuit [8]. To modulate the light and transmit information, the driver circuit controls the light intensity according to the baseband signal. Our work uses OpenVLC [6] as a LiFi transmitter.

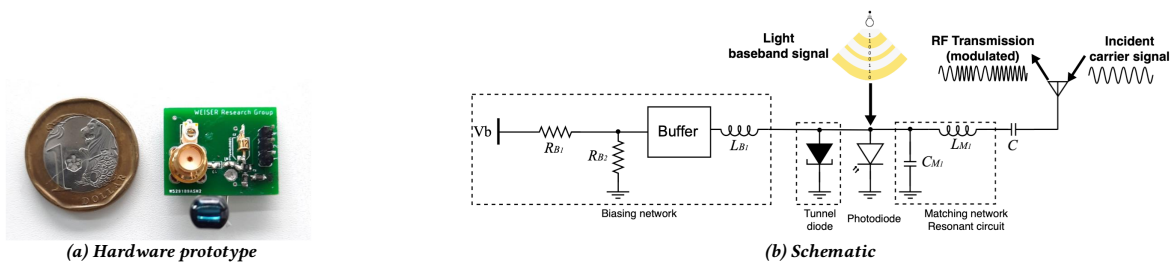

Figure 4: Chronology of events in TunnelliFi. First, we modulate the LiFi transmitter with the baseband signal. Using a TDO, we generate a high-frequency carrier within the 900-925MHz band. LiFi transmissions are received by a photodiode coupled with the TDO. Due to the SoM property of TDO, the baseband signal (LiFi) is mixed with the locally generated RF carrier signal. Finally, the mixed signal is radiated from the antenna and received by a commodity transceiver.

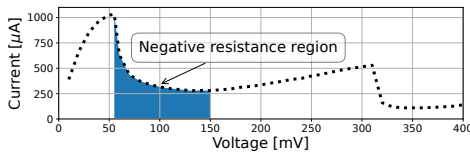

Figure 5: The I-V curve of a tunnel diode GE 1N 3712. Increasing the bias voltage causes a non-linear change in the current. The curve exhibits negative differential resistance at tens of microwatts of power consumption.

In this work, we use a 2-FSK and OOK modulated baseband signal to drive the control circuit. We generate baseband signals with frequencies varying between 100 kHz and 2.4 MHz.

3.2 TunnelliFi

In this section, we describe TunnelliFi, a key part of our system.

Tunnel diode oscillator. Tunnel diodes were the first semiconductor devices to demonstrate quantum tunneling, resulting in regions of negative resistance (RNR) with low power consumption (tens of microwatts). In this work, we use the GE 1N3712 tunnel diode and show its current-voltage (I-V) characteristics in Figure 5 [1]. As the bias voltage is increased across the diode, we observe a non-linear change in the current, with a negative differential slope.

Recent systems demonstrate the use of tunnel diodes as low-power oscillators [16, 17], and the TunnelliFi circuit design builds upon this concept. Our circuit, as shown in Figure 4b, comprises three key components: a matching network, a biasing circuit, and a modulating circuit. The biasing circuit is responsible for providing a precise bias voltage to the tunnel diode, which in turn allows it to operate in the RNR. The resonant circuit is made up of capacitors C_{M1} and inductors L_{M1} , controlling the frequency of the oscillating signals. Last, the modulating circuit mixes a baseband signal to the carrier signal using the SoM property of the TDO. The TDO can generate high-frequency RF carrier signals (at 900 MHz) at a peak power of less than 100 μ Ws.

Injection locking. TDO trades off the stability to achieve low power consumption. The RF carrier signal generated by TDO is therefore sensitive to various environmental factors: temperature, humidity, and motion near the TDO may affect its frequency [17]. By injection locking the TDO onto an external carrier signal, we counteract this instability. The experiment presented in this work uses a software-defined radio as an emitter device to provide a stable carrier signal. A very weak signal can be injection-locked, enabling the emitter device to be located at a considerable distance from the TunnelliFi device.

Integrating photodiode. To receive LiFi transmissions, tracking variations in light intensity is necessary. This is achieved using an active light receiver consisting of a photodiode and a TIA. TIAs can consume significant amounts of power. Our system, TunnelliFi, overcomes this limitation by devising a new approach to light sensing. Using a photodiode in combination with a TDO, we avoid power-intensive TIAs. Because TDOs function as SoMs, they mix baseband signals (from the photodiode) with an RF carrier signal.

Assuming a LiFi signal at frequency f_m and a carrier signal at frequency f_c , TunnelliFi generates a modulated RF signal with the frequency $f_c + f_m$ and its mirror image $f_c - f_m$. This approach enables us to efficiently shift the LiFi baseband signal from the light spectrum to the radio spectrum.

Implementation. Figure 4a shows the hardware prototype of TunnelliFi, designed using off-the-shelf components. The PCB uses an FR-4 substrate and a GE 1N3712 tunnel diode [1]. Signals are radiated out through a VERT900 antenna with a 3 dBi gain. We use SLD-70 photodiode [11] in the LiFi receiver, CC1310 as an off-the-shelf receiver [13], and Sound Hound BB60C spectrum analyzer [3] to capture the spectrum.

3.3 RF Receiver

Our system enables commodity devices to receive LiFi transmissions. As a result, we can receive transmissions from TunnelliFi using commodity radio transceivers. This paper demonstrates our system's communication capability with FSK modulation scheme. The receiver consists of a low-cost launchpad board with an amplifier and a transceiver (CC1310) [13]. Our system, however, is generic, and we will experiment with more complex modulation schemes and radio standards in the future.

4 EVALUATION

We perform multiple experiments to investigate the performance of TunnelliFi. The following are the major findings:

- TunnelliFi can replicate LiFi signals with a frequency as high as 2.4 MHz onto RF signals at tens of microwatts of power.
- TunnelliFi can operate under low-light condition with 300 lux.
- A weak external carrier signal can stabilize the TDO via injection locking, improving communication link quality.

We conduct experiments by biasing TDO to generate frequency in the 920-925 MHz frequency band. The carrier signal has a strength of -27 dBm, and the modulated signal appears at an offset frequency depending on the baseband signal's frequency. For example, we

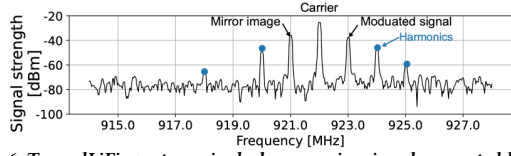

Figure 6: TunnelLiFi spectrum includes a carrier signal generated by TDO, a modulated signal (consisting of LiFi signal), and its mirror image after mixing.

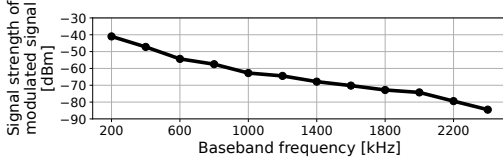

Figure 7: This graph demonstrates received RF signal strength (measured using CC1310), as we vary LiFi baseband frequency. The TunnelLiFi supports frequencies as high as 2.4 MHz, which corresponds to 4.8 Mbps (OOK modulation).

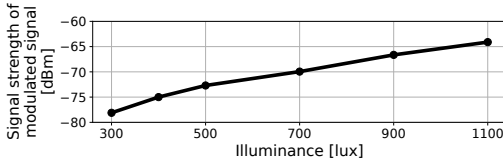

Figure 8: This graph show the ability of TunnelLiFi to operate in diverse light conditions. TunnelLiFi works at an illuminance level as low as 300 lux.

show the spectrum of the signal generated by the TunnelLiFi tag in Figure 6. We use a LiFi signal at 1 MHz. The modulated signal is at 923 MHz and its mirror image at 921 MHz.

4.1 LiFi Modulation Frequency

We evaluate the impact of LiFi modulation frequency on TunnelLiFi transmission. In this experiment, we conduct the experiment without an external emitter device. The LiFi signal is driven by a digital signal (PWM) with a frequency varying from 100 KHz to 2.4 MHz. We analyze the spectrum of RF signal generated by the TunnelLiFi tag and record the modulated signal strength. The illuminance at the photodiode is 800 lux (for comparison, typically suggested indoor illumination is about 500 lux). The result in Figure 7 shows that our system can replicate LiFi signals up to 2.4 MHz onto RF signals. In terms of throughput, 2.4 MHz corresponds to 4.8 Mbps (for the OOK modulation scheme), as each frequency cycle may be considered to be composed of two bits (1 and 0). When compared to the state-of-the-art system PassiveLiFi [10], we achieve at least an order of magnitude higher baseband frequency, and throughput.

4.2 Light Intensity

In this experiment, we investigate the impact of light intensity on modulated signal strength. We conducted experiments in the absence of emitter device. To change the optical power the photodiode receives, we change the distance between the LiFi transmitter and the photodiode or the bias voltage on the LED. The LiFi modulation frequency is set at 1 MHz, and the effects of light intensity on the modulated signal are shown in Figure 8. We observe that the light intensity is proportional to the strength of the modulated signal. Higher light intensity generates a stronger photodiode current, which enhances the strength of the modulated signal.

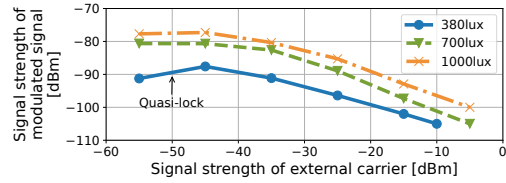

Figure 9: This graph demonstrates the impact of an external carrier signal on the injection-locking ability of TunnelLiFi. Surprisingly, we find that modulated signal (from mixing a photodiode signal with a carrier signal) is stronger when a weak carrier signal is generated from the emitter device.

4.3 RF Carrier Strength

The external carrier signal helps to stabilize the TDO via injection locking. Because of the strength of the carrier signal is a key factor in determining the injection locking state, we experimentally investigate its impact. We vary the strength of the carrier signal and record the modulated signal generated by the TunnelLiFi tag. We perform the experiment at three light intensity levels (380, 700, and 1000 lux) by placing the LiFi transmitter at different distances from the photodiode. The results are presented in Figure 9. We observe that for a weaker but sufficient external carrier, the modulated signal is stronger. When the carrier strength is just below the injection locking level, e.g. below -45 dBm in the case of 380 lux, the TDO is pushed to one edge of the lock range and reaches a quasi-lock state. When the carrier signal strength is too strong, the TDO is pulled out of the injection locking state, which makes the modulated signal weaker. As TDO can latch on a weak carrier signal, it allows greater flexibility in emitter positioning, and the emitter device can be located a significant distance away from the setup.

4.4 Link Quality

Finally, we evaluate the ability of TunnelLiFi to replicate modulated LiFi transmissions, which are then received by commodity transceivers. We use USRP B210 as emitter device, to provide a carrier signal for injection locking. The TunnelLiFi tag, emitter device, and receiver are equipped with 3 dBi omnidirectional antennas. In this early experiment, we focus on the 2-FSK modulation scheme and configure the LiFi baseband signal at a low bitrate of 2.93 Kbps with 15 kHz frequency deviation. We use bit error rate (BER) and received signal strength (RSS) as link metrics. In each run of our experiments, we transmit a fixed number of packets (1000) of length 32 B with a random payload. We disable the cyclic redundancy check (CRC) that allows us to retain the corrupt bits. We only consider the successfully received packets and compare the received sequence with the baseline sequence.

We conduct the experiments in an office room at the university. The light source is 0.5 m away from the transmitter, ensuring an illuminance of 700 lux. The emitter device is positioned at a distance of 3 m from the setup. We generate a weak carrier signal of strength -45 dBm. The TunnelLiFi and emitter device are placed in the office, and the receiver is placed NLoS at locations 1, 2, and 3 in the corridor with distances of 2, 10, and 12 m, respectively, from the TunnelLiFi tag. Figure 10 shows the results. We observe that the BER is well below 10^{-1} . The BER increases when the RSS approaches the noise floor of the receiver (-110 dBm). The link quality is poor. Because TunnelLiFi uses simple 2-FSK modulation without any coding mechanisms, we can attribute this to its poor link quality.

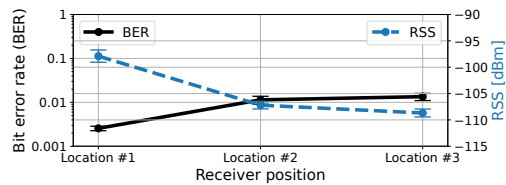

(a) BER and RSS for the light illuminance of 600 lux (Indoor).

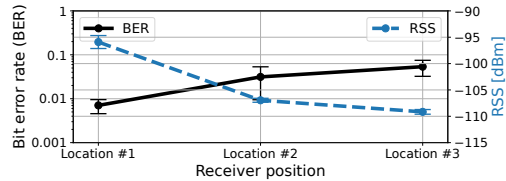

(b) BER and RSS for the light illuminance of 1000 lux (Indoor).

Figure 10: We evaluate the link metrics with the transmitter configured at low bitrate (2.93 Kbps). We change the location of the receiver. The link metrics and quality deteriorate at lower signal strengths.

To improve link reliability, spread spectrum techniques and forward error correction can be utilized.

Next, we compute the maximum communication range using the Friis transmission formula, which provides an intuitive representation of the system’s communication capability. We use the CC1310 sensitivity (-110 dBm) as a reference of the receiver, and consider the 900 MHz frequency band. Our experiments show mixed signal strengths ranging from -19 to -50 dBm, depending on the setup. Using these values, we calculate the corresponding theoretical communication range. For a signal strength of -19 dBm, the maximum range is 940 m, whereas for a signal strength of -50 dBm, the maximum range is 26 m.

4.5 Power Consumption

We compare the power consumption among an active receiver from OpenVLC, a passive receiver from PassiveLiFi [10], and TunnelLiFi. Table 1 presents results. The active receiver offers high bandwidth but at the expense of high power consumption due to dual amplification stages and high input voltage (5 V). The passive receiver uses a solar cell for reception and a low-power comparator to reduce the overall power consumption, but its performance is limited by the low bandwidth of the solar cell (~ 100 KHz). In comparison, TunnelLiFi offers high bandwidth with low power consumption of $48 \mu\text{W}$. In the TunnelLiFi design, the photodiode serves as a passive element that can be considered to consume zero power. In addition, the tunnel diode operates at a low bias voltage allowing energy-efficient operation.

5 DISCUSSION

This study presents our early work, TunnelLiFi. We discuss some future research directions that we envision for our system.

Compatibility with IoT wireless standards. The IoT ecosystem comprises a range of communication technologies, including ZigBee, Bluetooth, WiFi, and LoRa. The selection of technology depends on various factors. However, TunnelLiFi has the potential to be agnostic to the technology selected in the radio spectrum, and may even be able to support multiple technologies in the future. To do so, the LiFi transmitter is modulated with the baseband signal to conform to the desired waveform. Our future work will involve

Table 1: Power consumption comparison

LiFi receiver	f_m (kHz)	Power cons. (mW)
Active [6]	100	207
(with photodiode)	1000	225
Passive [10]	100	0.002
(with solar cell)	1000	–
TunnelLiFi	100	0.048
(proposed)	1000	0.052

exploring and evaluating the possibility of supporting multiple IoT technologies with TunnelLiFi.

Bidirectional communication. Supporting IoT protocols may require bidirectional communication, such as sending acknowledgment messages. Nevertheless, we are currently unable to support bidirectional communication. Thus, TunnelLiFi is well-suited to applications that require only unidirectional communication. However, we can enable bidirectional communication by transmitting feedback via RF to the LiFi transmitter or the TunnelLiFi transmitter, which can then relay information to the LiFi transmitter. We aim to explore this as our future work.

Increasing throughput. Various factors influence the throughput of TunnelLiFi. The advantage of TunnelLiFi is that it uses the self-mixing property of the TDO and directly couples the locally generated carrier signal with the photodiode’s signal without requiring any processing blocks. This results in no delays or overheads owing to processing, potentially improving throughput. However, the throughput may be limited by the characteristics of the LED used in the LiFi transmitter, such as bandwidth; this requires further investigation. In addition, TDOs are noisy, especially without an external carrier, which can degrade the signal-to-noise ratio and adversely affect the mixed signal.

6 CONCLUSION

Here we have presented our early work, TunnelLiFi, which offers a novel LiFi receiver architecture. This receiver acts like a low-power LiFi-RF bridge, and replicates information contained in LiFi transmissions onto radio waves. Using the TDO SoM property, TunnelLiFi can mix an optical signal with an RF carrier signal while using less than $100 \mu\text{W}$ of power, resulting in unprecedented energy efficiency. Our initial results show that TunnelLiFi is capable of translating low data rate transmissions even in very low light conditions, making it a promising technology for IoT devices. TunnelLiFi enables several different application scenarios, and takes a step towards widespread deployment of the LiFi technology.

7 ACKNOWLEDGEMENTS

We thank our shepherd Ali Abedi (Stanford University) and anonymous reviewers whose comments have been helpful to improve this manuscript. Part of this work was supported by the project RISC-6G, reference TSI-063000-2021-59, granted by the Ministry of Economic Affairs and Digital Transformation and the European Union-NextGenerationEU through the UNICO-5G R&D Program of the Spanish Recovery, Transformation, and Resilience Plan. The work has also been partially funded by a startup grant from the National University of Singapore, and 2019 ABB Research Award in Honour of Hubertus von Grünberg hosted at University of California, Berkeley. Wenqing Yan was supported by the Swedish Foundation for Strategic Research (SSF) (RIT17-0020) and the Swedish Science Foundation (2018-05480).

REFERENCES

- [1] General Electric. Tunnel Diode 1N3712. <http://w140.com/tekwiki/wiki/1N3712>.
- [2] Francesco Amato, Christopher W Peterson, Muhammad B Akbar, and Gregory D Durgin. Long range and low powered rfid tags with tunnel diode. In *2015 IEEE International Conference on RFID Technology and Applications (RFID-TA)*, pages 182–187. IEEE, 2015.
- [3] Signal Hound BB60C. <https://signalhound.com/products/bb60c/>.
- [4] Christos Danakis, Mostafa Afgani, Gordon Povey, Ian Underwood, and Harald Haas. Using a cmos camera sensor for visible light communication. In *2012 IEEE Globecom Workshops*, pages 1244–1248, 2012.
- [5] Paul Dietz, William Yerazunis, and Darren Leigh. Very low-cost sensing and communication using bidirectional leds. In *International Conference on Ubiquitous Computing*, pages 175–191. Springer, 2003.
- [6] Ander Galisteo, Diego Juara, and Domenico Giustiniano. Research in visible light communication systems with OpenVLC1.3. In *Proceedings of the 2019 IEEE 5th World Forum on Internet of Things, WF-IoT*, 2019.
- [7] Ander Galisteo, Ambuj Varshney, and Domenico Giustiniano. Two to tango: Hybrid light and backscatter networks for next billion devices. In *Proceedings of the 18th International Conference on Mobile Systems, Applications, and Services, MobiSys'20*, page 80–93. ACM, 2020.
- [8] Kasun Hewage, Ambuj Varshney, Abdalah Hilmia, and Thiemo Voigt. Modbulb: A modular light bulb for visible light communication. In *Proceedings of the 3rd Workshop on Visible Light Communication Systems, VLCS '16*, page 13–18, New York, NY, USA, 2016. Association for Computing Machinery.
- [9] Jiangtao Li, Angli Liu, Guobin Shen, Liqun Li, Chao Sun, and Feng Zhao. Retro-vlc: Enabling battery-free duplex visible light communication for mobile and iot applications. In *Proceedings of the 16th International Workshop on Mobile Computing Systems and Applications, HotMobile '15*, page 21–26, New York, NY, USA, 2015. Association for Computing Machinery.
- [10] Muhammad Sarmad Mir, Borja Genoves Guzman, Ambuj Varshney, and Domenico Giustiniano. PassiveLiFi: Rethinking LiFi for low-power and long range RF backscatter. In *Proceedings of the 27th Annual International Conference on Mobile Computing and Networking, MobiCom'21*, pages 697–709, 2021.
- [11] Advanced photonix SLD-70. <https://www.advancedphotonix.com/wp-content/uploads/2022/03/DS-SLD-70BG2.pdf>.
- [12] RCA Corporation. Semiconductor and Materials Division. *RCA Tunnel Diode Manual*. RCA technical manual. RCA, 1963.
- [13] Texas Instruments. CC1310 launchpad. <http://www.ti.com/tool/launchxl-cc1310>.
- [14] Zhao Tian, Kevin Wright, and Xia Zhou. The darklight rises: Visible light communication in the dark: Demo. In *Proceedings of the 22nd Annual International Conference on Mobile Computing and Networking, MobiCom '16*, page 495–496, New York, NY, USA, 2016. Association for Computing Machinery.
- [15] Tsun-Ting Tsai, Chi-Wai Chow, Yun-Han Chang, Yin-He Jian, Yang Liu, and Chien-Hung Yeh. 130-m image sensor based visible light communication (VLC) using under-sample modulation and spatial modulation. *Optics Communications*, 519:128405, 2022.
- [16] Ambuj Varshney, Andreas Soleiman, and Thiemo Voigt. Tunnelscatter: Low power communication for sensor tags using tunnel diodes. In *Proceedings of the 25th Annual International Conference on Mobile Computing and Networking, MobiCom'19*. ACM, 2019.
- [17] Ambuj Varshney, Wenqing Yan, and Prabal Dutta. Judo: Addressing the energy asymmetry of wireless embedded systems through tunnel diode based wireless transmitters. In *Proceedings of the 20th Annual International Conference on Mobile Systems, Applications and Services, MobiSys' 22*. ACM, 2022.
- [18] Ju Wang, Omid Abari, and Srinivasan Keshav. Challenge: RFID hacking for fun and profit. In *Proceedings of the 24th Annual International Conference on Mobile Computing and Networking, MobiCom'18*. ACM, 2018.
- [19] Zixiong Wang, Dobrosław Tsonev, Stefan Videv, and Harald Haas. On the design of a solar-panel receiver for optical wireless communications with simultaneous energy harvesting. *IEEE Journal on Selected Areas in Communications*, 33(8):1612–1623, 2015.